



MT5A61E01K

TI IWR1642 mmWave Sensor

Application Kit

User Guide

Revision 2

Prepared By	Reviewed By	Approved By

Index

1. INTRODUCTION	2
1.1. GENERAL FEATURES	2
1.2. KIT CONTENTS	2
2. HARDWARE INFORMATION	3
2.1. DEVICE VIEW	3
2.2. POWER CONNECTION	4
2.3. PC CONNECTION	5
2.4. SOP MODE BY SLIDE SWITCH	5
2.5. RESET BUTTON AND LEDs.....	6
2.6. GOPRO MOUNT	6
2.7. ANTENNA PERFORMANCE	7
3. SOFTWARE INFORMATION.....	8
3.1. SOFTWARE DEVELOPMENT KIT	8
3.2. PROGRAMMING TOOL	8
3.3. APPLICATION RESOURCE	9
4. DEVICE DIMENSION.....	10
5. ORDERING INFORMATION	10
6. HISTORY CHANGE	10

1. INTRODUCTION

The MT5A61E01K is the sensor application kit which integrates Texas Instruments' industrial mmWave technology. This device targets low power and ultra-accurate mmWave systems in security, industrial, and personal health care applications.

The MT5A61E01K simplifies the implementation of mmWave sensors in the band of 76 to 81GHz, and it includes the ARM Cortex-R4F based processor system, 2Tx 4Rx antenna with specific SDK (Software Development Kit) for diverse applications, such as environment monitor, equipment inspection and maintain, personal health care, and objects' detection.

1.1. General Features

- Built-in Antenna
- XDS110 based JTAG emulation with a serial port for internal QSPI flash programming
- Back-channel UART through USB-to-PC for logging purposes
- Two LEDs for basic user interface
- Micro USB connector
- 5V Power Jack to the device
- GOPRO mount buckles
- Dimensions: 78 mm (L) x 64 mm (W) x 23.5 mm (H)

1.2. Kit Contents

- MT5A61E01K Device
- 5V 2A Power Adapter with a 2.1-mm barrel jack
- GoPro Tripod Mount Connector with Screw

2. HARDWARE INFORMATION

2.1. Device View

Figure 2-1 to 2-3 shows the MT5A61E01K mmWave Device.

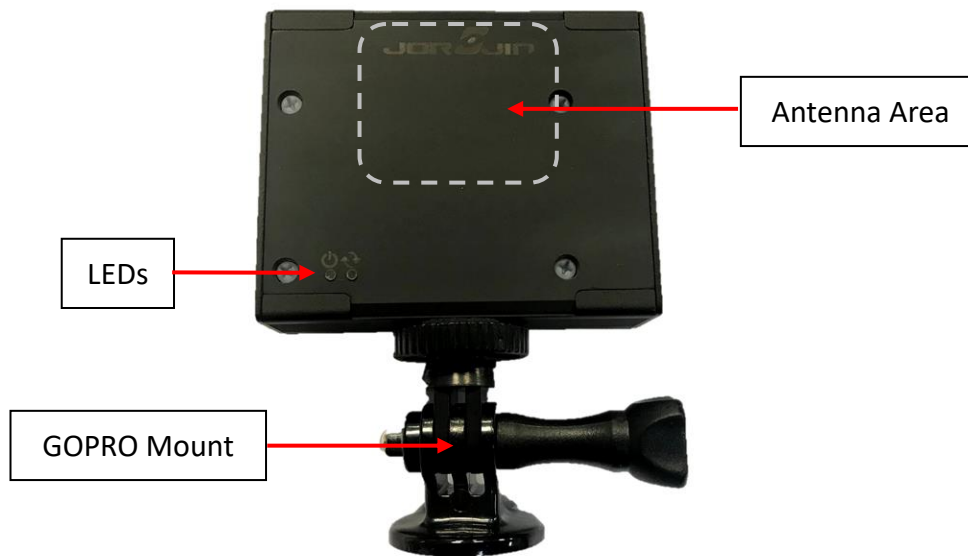

Figure 2-1. Front View

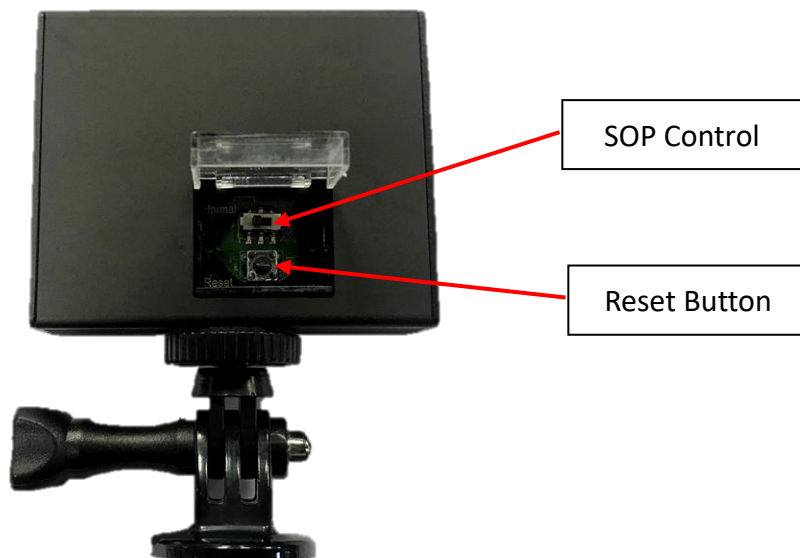

Figure 2-2. Back View

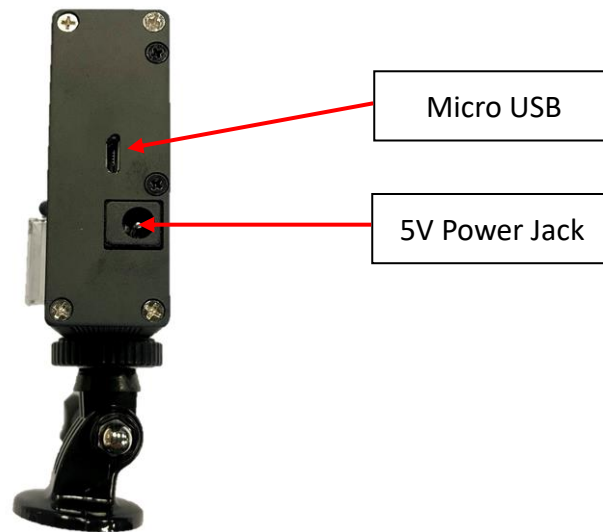

Figure 2-3. Side View

2.2. Power Connection

The mmWave device is powered by the 5-V power jack, shown in [Figure 2-4](#). As soon as the power is provided, the Reset and Power LED should glow, indicating that the device is powered on.

Note: After the 5V power supply is provided to the device, it is recommended to press the Reset button one time to ensure a reliable boot-up state.



Figure 2-4. Power Connection

2.3. PC Connection

The connectivity is provided through the micro USB connector over the onboard XDS110 emulator. This connection provides the following interfaces to the PC:

- JTAG for Code Composer Studio™ (CCS) connectivity
- UART1 for flashing the onboard serial flash, downloading FW through Radar Studio, and getting application data sent through the UART
- MSS logger UART (can be used to get MSS code logs on the PC)

When the USB is connected to the PC, the device manager should recognize the following COM ports, shown in [Figure 2-5](#):

XDS110 Class Application/User UART – UART1 port

XDS110 Class Auxiliary Data Port – MSS logger port



Figure 2-5. PC COM Ports

2.4. SOP mode by Slide Switch

The mmWave device can be set to operate in two different modes based on the state of the SOP slide switch. The state of the device is detailed by [Table 2-1](#).

Table 2-1. SOP mode Switch List

Reference	State	Comments
SOP mode-4	Normal mode	Slide switch move left
SOP mode-5	Flash programming	Slide switch move right

[Figure 2-6 to 2-7](#) shows the SOP mode by slide switch.

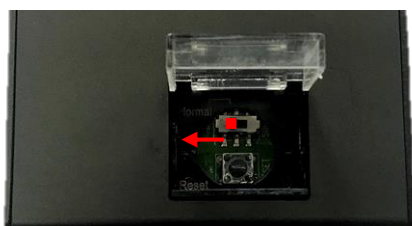

Figure 2-6. SOP mode-4

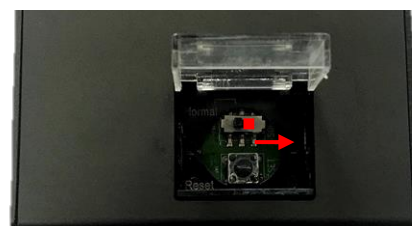

Figure 2-7. SOP mode-5

2.5. Reset Button and LEDs

Table 2-2 provides the Reset and LEDs information.

Table 2-2. Reset and LEDs information

Reference	Usage	Comments
Reset button	RESET	Used to reset the mmWave device.
Red LED	5V supply indication	The LED indicates the presence of the 5V supply.
Green LED	nReset indication	The LED is used to indicate the state of nRESET pin. If the LED is glowing, the device is out of reset. The LED will glow only after the 5V supply is provided.

2.6. GOPRO Mount

The MT5A61E01K device use the mounting that similar the Gopro. You can use the connector of Kit contents to connect tripod for setup and adjust the device angle easily. Shows in [Figure 2-8](#).



Figure 2-8. Gopro Mount explosion drawing

2.7. Antenna Performance

The peak gain of MT5A61E01K Antenna is > 9 dBi across the operating frequency band of 76 to 81 GHz. The peak output power with the antenna gain around 25 dBm EIRP. The radiation pattern of the antenna in the horizontal plane (H-plane , Phi = 0 degrees) and elevation plane (E-plane , Phi= 90 degrees) is shown in Figure 2-9.

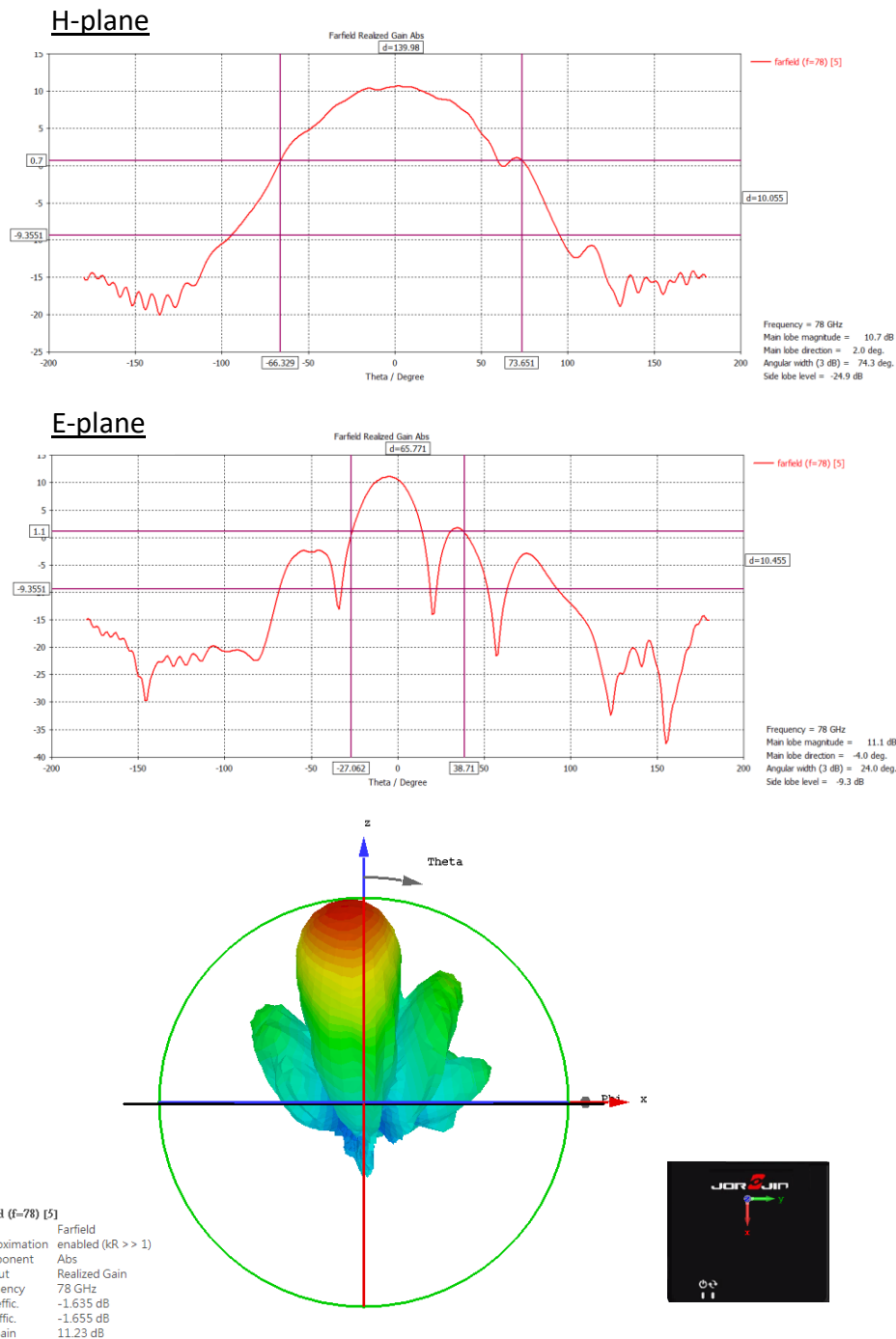
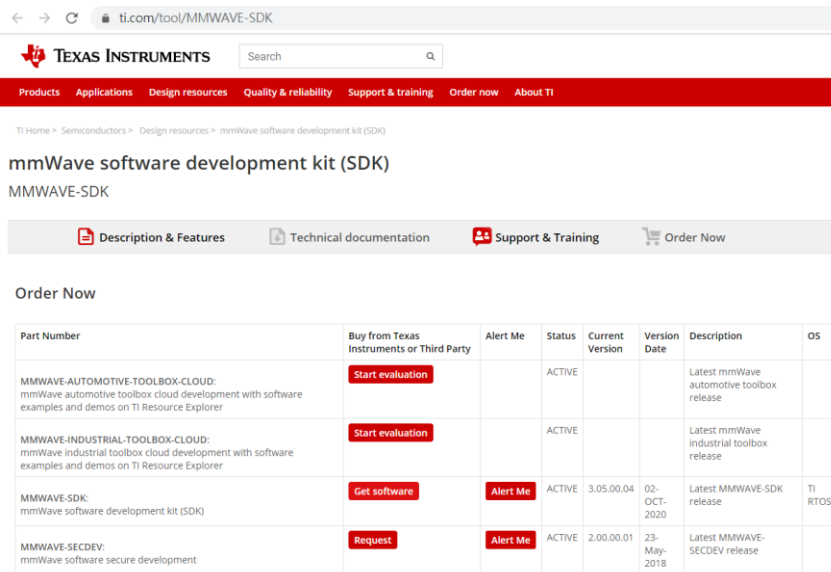

Figure 2-9. Antenna Pattern

3. SOFTWARE INFORMATION

3.1. Software Development Kit

The MT5A61E01K mmWave device design that based on TI IWR1642 ES2.0. The software development kit (SDK) includes demo codes 、 software drivers 、 emulation packages for debug and more that can be found at [mmwave-sdk](https://www.ti.com/tool/MMWAVE-SDK).



Part Number	Buy from Texas Instruments or Third Party	Alert Me	Status	Current Version	Version Date	Description	OS
MMWAVE-AUTOMOTIVE-TOOLBOX-CLOUD: mmWave automotive toolbox cloud development with software examples and demos on TI Resource Explorer	Start evaluation		ACTIVE			Latest mmWave automotive toolbox release	
MMWAVE-INDUSTRIAL-TOOLBOX-CLOUD: mmWave industrial toolbox cloud development with software examples and demos on TI Resource Explorer	Start evaluation		ACTIVE			Latest mmWave industrial toolbox release	
MMWAVE-SDK: mmWave software development kit (SDK)	Get software	Alert Me	ACTIVE	3.05.00.04	02-OCT-2020	Latest MMWAVE-SDK release	TI RTOS
MMWAVE-SECDEV: mmWave software secure development	Request	Alert Me	ACTIVE	2.00.00.01	23-May-2018	Latest MMWAVE-SECDEV release	

3.2. Programming Tool

The UniFlash Programmer for Texas Instruments devices that provides a single interface for programming Flash memory and executing Flash based operations on supported targets. Can be found at [UniFlash](https://www.ti.com/tool/download/UNIFLASH).

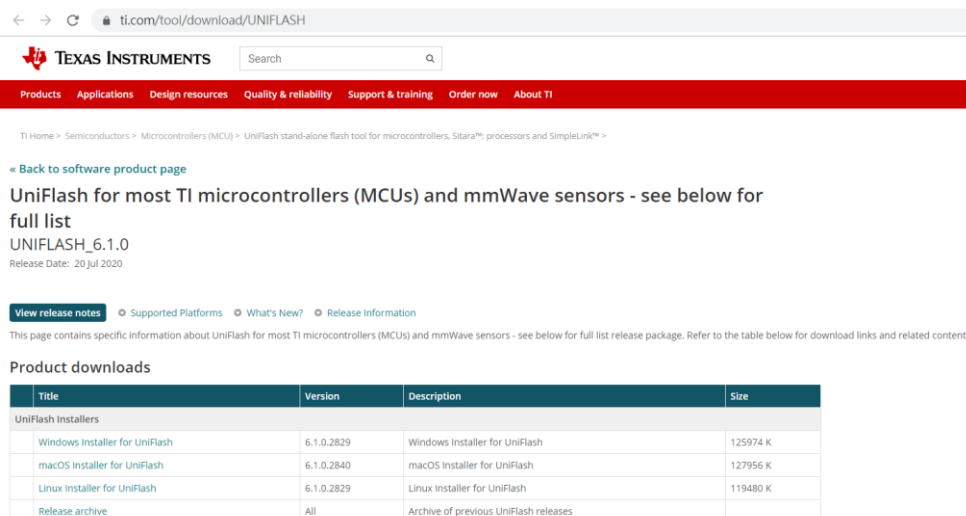

Product downloads

Title	Version	Description	Size
UniFlash Installers			
Windows Installer for UniFlash	6.1.0.2829	Windows Installer for UniFlash	125974 K
macOS installer for UniFlash	6.1.0.2840	macOS installer for UniFlash	127956 K
Linux installer for UniFlash	6.1.0.2829	Linux Installer for UniFlash	119480 K
Release archive	All	Archive of previous UniFlash releases	

3.3. Application Resource

There are some application experiments at [TI Resource Explorer](#) include people counting、traffic monitoring、vital signs and more that help to understand the design detail.

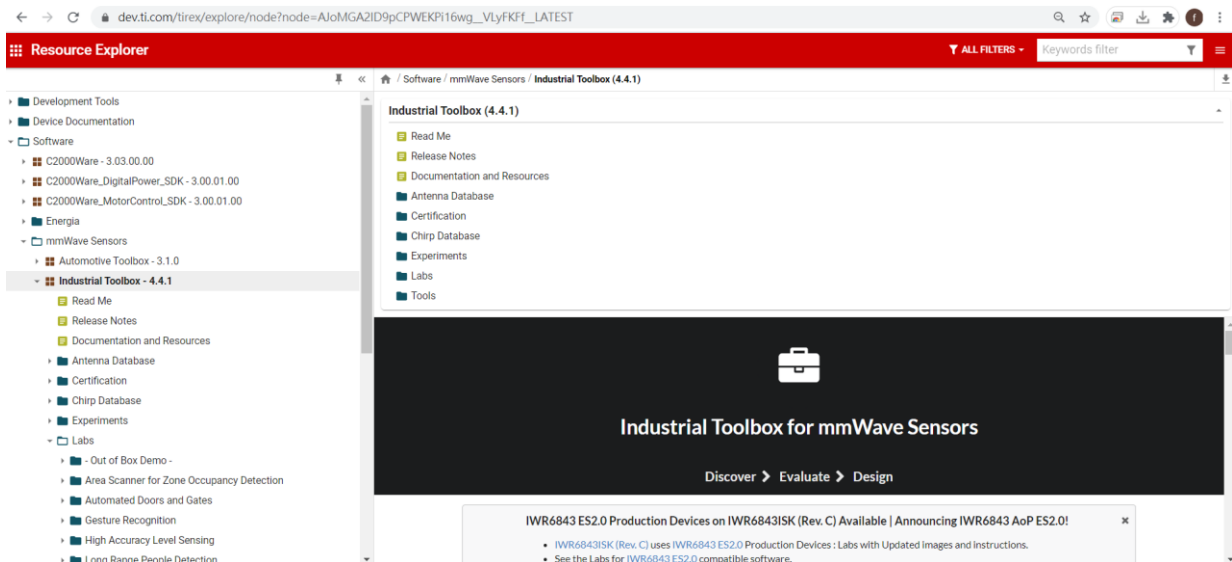

4. DEVICE DIMENSION

Figure 4-1 shows the device dimension.

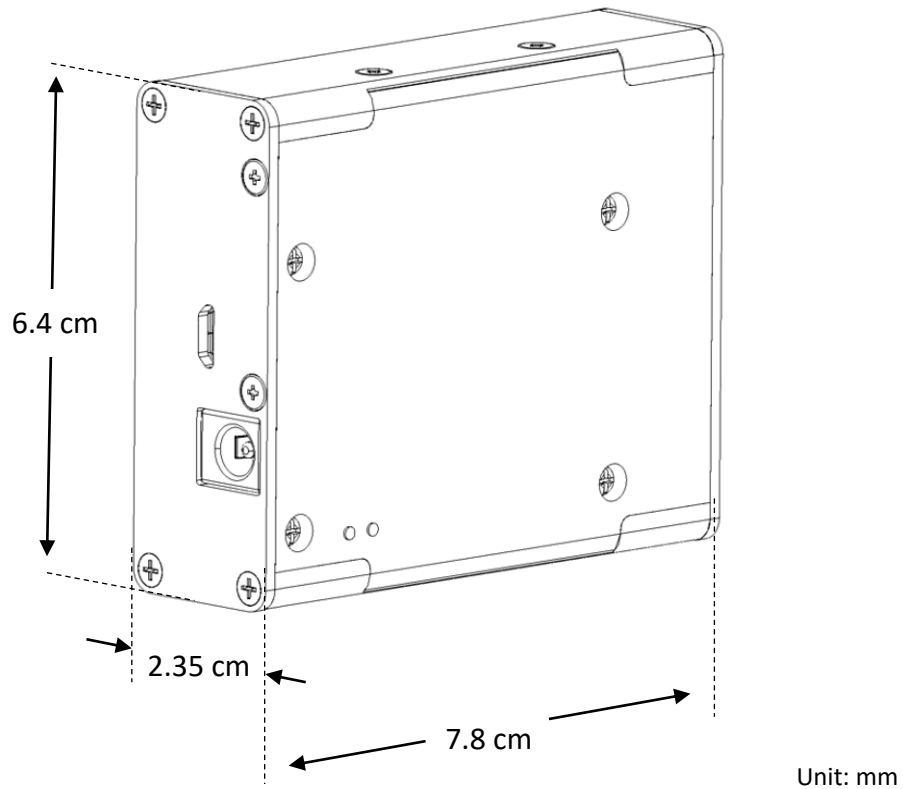

Figure 4-1. MT5A61E01K Device Drawing

5. ORDERING INFORMATION

Part number:	MT5A61E01K
--------------	------------

6. HISTORY CHANGE

Revision	Date	Description
Revision 1	2018-10-01	Official Released.
Revision 2	2021-03-03	Modify device mechanical